

ITEM	DESCRIPTION	DETAIL	MATERIAL	Q'TY
1	CAP CASTING	SD534	FC 200	1
2	BASE CASTING	SD534	FC 200	1
3	HEX.HEAD BOLT	M24×3.0P×140LG	AISI-1010	4
4	LOCK WASHER	M24	AISI-1045	4
5	DOWEL PIN	φ1/2"×38LG	AISI-1010	2
6	EYE BOLT	W3/8"	AISI-1010	2
7	GREASE NIPPLE	PT 1/4	AISI-1010	1
8	METAL PLUG	PT 1/4	AISI-1010	2

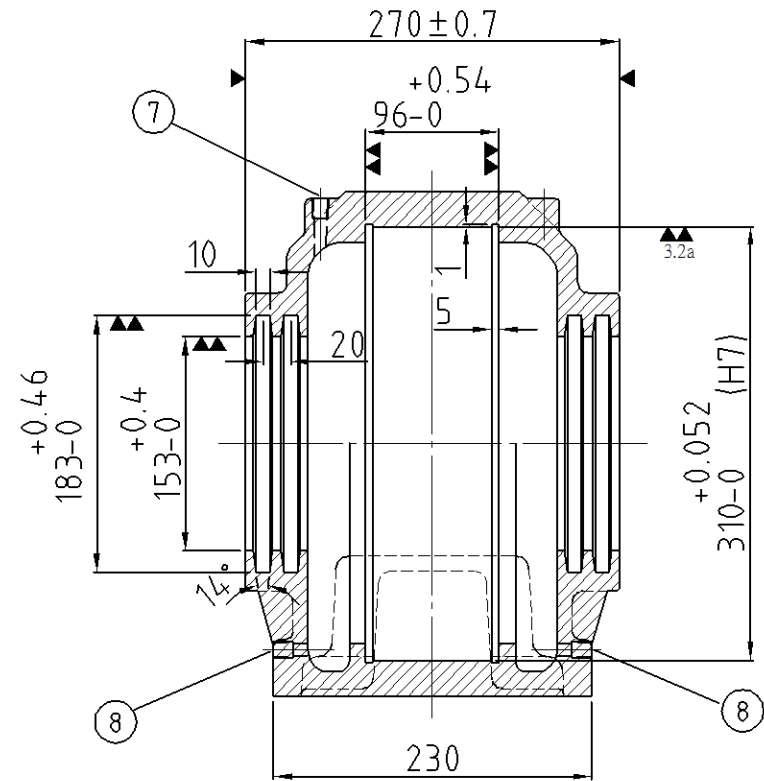
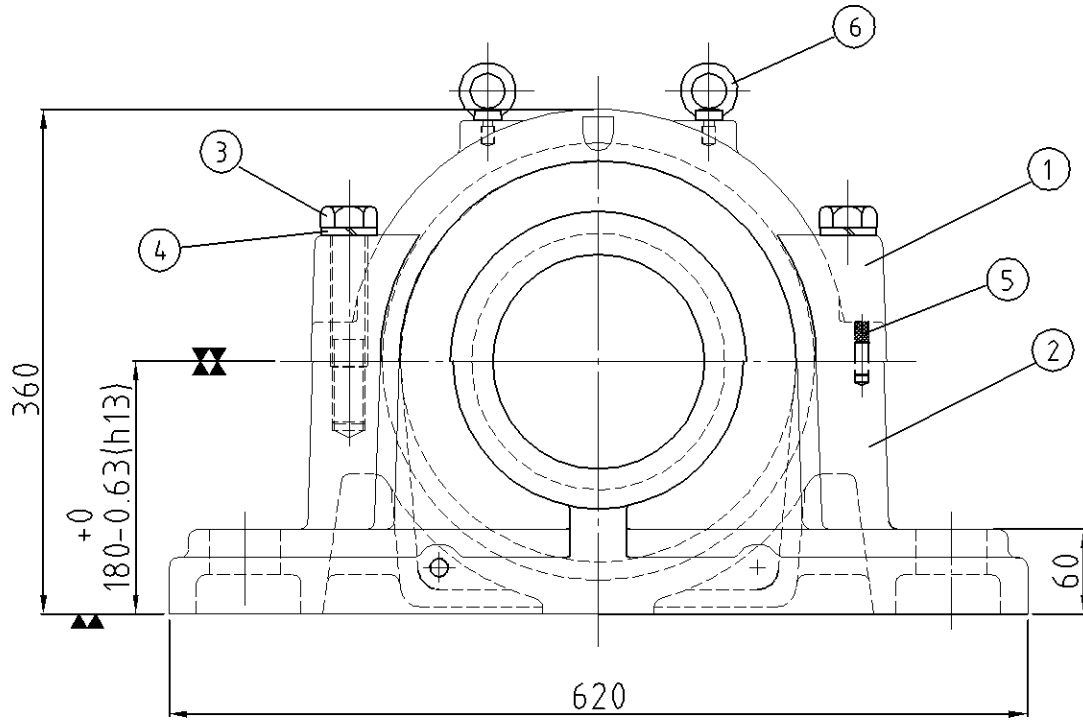

FAIR FRIEND ENT. GROUP.

NAME		DATE	FSQ FAIRSKQ (TAIWAN) CO., LTD.		
DRAWN	C.M.T	2010/09/21			
CHECKED	K.Y.S	2010/09/21	DRAWING NAME	DRAWING NO	EDITION
SCALE		Issue	SD534	PB19534D	00

敬告 RESTRICTED
 此圖乃友迦工業(股)公司財產,未經本公司正式授權,不得私自影印或將內容透漏與第三者。
 THIS DRAWING IS PROPERTY OF FAIRSKQ (TAIWAN) CO., LTD. AND IS TRANSMITTED TO YOU AS A CONFIDENTIAL DISCLOSURE. IT SHALL NOT BE COPIED OR IT'S CONTENTS REVEALED TO OUTSIDE PARTIES WITHOUT WRITTEN CONSENT OF FAIRSKQ (TAIWAN) CO., LTD.

REV.	MARK	CAREER	NAME	DATE