

ITEM	DESCRIPTION	DETAIL	MATERIAL	Q'TY
1	CAP CASTING	SNZ330	GRADE200	1
2	BASE CASTING	SNZ330	GRADE200	1
3	HEX.HEAD BOLT	M30x3.5Px170LG	AISI-1010	2
4	LOCK WASHER	M24	AISI-1045	2
5	DOWEL PIN	φ8x16LG	AISI-1045	2
6	GREASE NIPPLE	PT 1/4	AISI-1010	1
7	METAL PLUG	PT 1/4	AISI-1010	1
8	EYE BOLT	W1/2"	AISI-1010	1

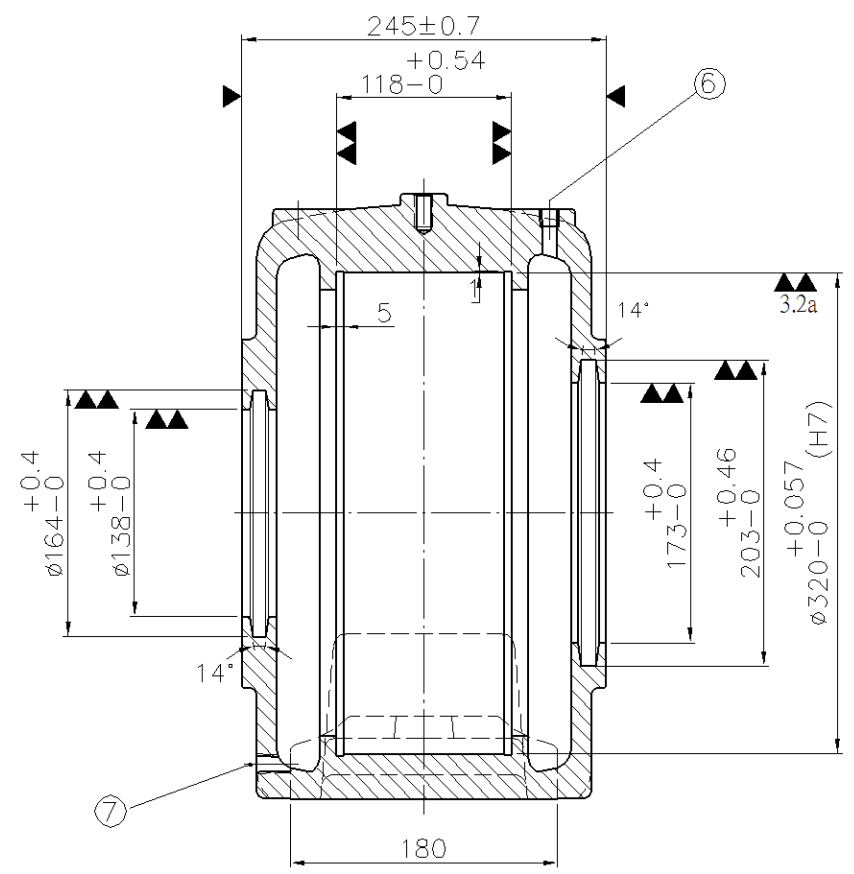

FAIR FRIEND ENT. GROUP.

NAME		DATE		FSQ FAIRSKQ (TAIWAN) CO., LTD.		
DRAWN	H.S.Y	2010/11/23				
CHECKED	K.Y.S	2010/11/23		SNZ330	PB37330D	00
SCALE		Issue				

敬告 RESTRICTED

此圖乃友迦工業(股)公司財產,未經本公司正式授權,不得私自影印或將內容透漏與第三者。
 THIS DRAWING IS PROPERTY OF FAIRSKQ (TAIWAN) CO., LTD. AND IS TRANSMITTED TO YOU AS A CONFIDENTIAL DISCLOSURE. IT SHALL NOT BE COPIED OR IT'S CONTENTS REVEALED TO OUTSIDE PARTIES WITHOUT WRITTEN CONSENT OF FAIRSKQ (TAIWAN) CO., LTD.

REV.	MARK	CAREER	NAME	DATE